



COMMERCIAL

# TX3800 SERIES

- TX3800 Series • TX3820 Series



INSTRUCTION MANUAL

## CONTENTS

INTRODUCTION . . . . .	2	GROUP SELCALLS . . . . .	16
FEATURES . . . . .	2	DTMF (Dual Tone Multiple Frequency) . . . . .	18
FRONT PANEL CONTROLS . . . . .	3	PAGE MODE . . . . .	18
MC522BC – MICROPHONE CONTROLS . . . . .	4	CTCSS/DCS . . . . .	20
PROGRAMMABLE FUNCTIONS . . . . .	5	INSTALLATION . . . . .	20
STANDARD FUNCTIONS . . . . .	5	OPTIONAL MICROPHONE . . . . .	22
USING THE PROGRAMMABLE FUNCTIONS . . . . .	7	SPECIFICATIONS . . . . .	23
SCANNING . . . . .	10	WARRANTY . . . . .	Back Page
SELECTIVE CALLING . . . . .	12		

## THE FOLLOWING ITEMS ARE INCLUDED WITH YOUR TX3800 SERIES

- |                             |                            |   |
|-----------------------------|----------------------------|---|
| • TX3800 Series Radio       | • Adaptor for Lead         | • Screw Pack  |
| • Mounting Cradle           | • Adaptor Mounting Bracket | If any items are missing or damaged, please contact your retailer or place of purchase. |
| • Instruction Manual        | • Microphone Clip          |   |
| • Microphone Extension Lead | • DC Lead                  |   |

## INTRODUCTION

The GME TX3800 Series of Commercial UHF radios has been wholly designed and manufactured in Australia by Standard Communications Pty. Ltd. to meet the requirements of commercial radio users.

The TX3800 Series combines the very latest in electronic hardware with computer aided design and manufacturing techniques to produce a compact mobile commercial radio with outstanding features, specifications and performance.

## FEATURES

- Strong die cast metal construction.
- Tested to MIL-STD 810C/D/E standards for shock, vibration, humidity and dust.
- Simple-to-use Controls – rotating on/off volume control and channel switch and push button function keys.
- Up to 99 simplex and semi-duplex channels. In addition, all 40 UHF CB channels may be programmed if required. (UHF Model only).
- Illuminated high contrast alpha-numeric Liquid Crystal Display (LCD) provides a visual indication of all selected functions at a glance.
- Alpha-numeric labelling of selected channels simplifies channel selection and Identification of incoming callers.
- Four scanning modes available including 'Multi-trunk' (busy channel voting) and Signal Strength voting.
- Transmitter output power of 25 Watts, switchable to 5 Watts.
- Priority channel feature allows your working or local repeater channel to be instantly recalled at the press of a key.
- The very latest surface mount component types, design and assembly techniques and quality control procedures are used to ensure the highest performance and reliability.
- Unique Transpond Mode allows you to transfer an incoming Selcall to another radio if your radio is unattended.
- Microprocessor Controlled Frequency Synthesiser provides user programmable control of scanning, channel memories and selected feature options.
- Permanent Memory retains all user settings in non-volatile memory even when the power has been removed.
- DTMF Signalling using preprogrammed speed dial keys.
- Built-in Selcall (up to 8 tones) with Alphanumeric ANI.
- A built-in Continuous Tone Coded Squelch System (CTCSS) and Digitally Coded Squelch (DCS) option provides quiet channel operation.

## FRONT PANEL CONTROLS

### FRONT PANEL CONTROLS

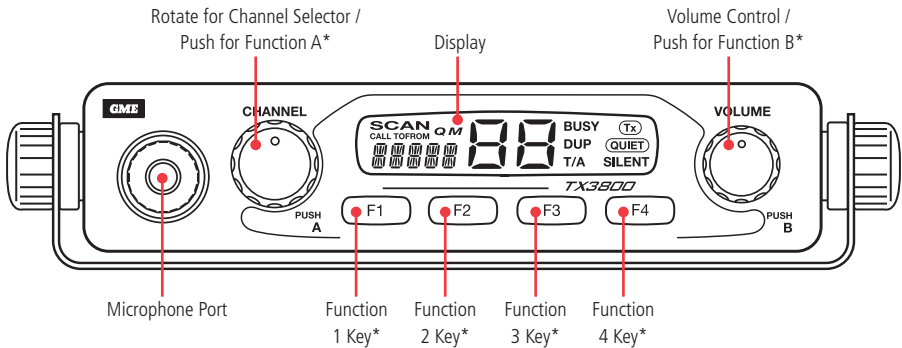

\* See table on Page 5 for programmable functions.

### FRONT PANEL LCD INDICATORS

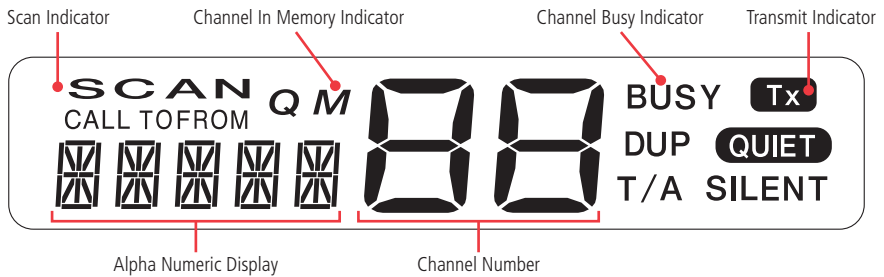

## MICROPHONE CONTROLS



\* See table on Page 5 for programmable functions.

## MICROPHONE LCD INDICATORS

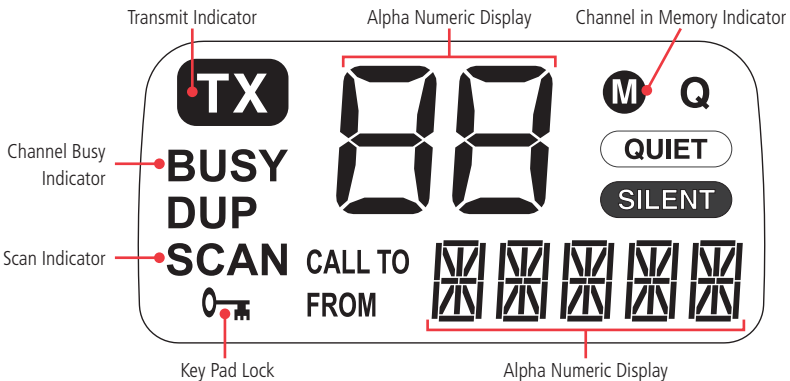

## PROGRAMMABLE FUNCTIONS

FUNCTION	A	F1	F2	F3	F4	B	FUNCTION	A	F1	F2	F3	F4	B
Transmit Hi/Lo Power							Recall CH M1 + Dial DTMF M1						
Monitor							Recall CH M1 + Dial DTMF M2						
Squelch							Recall CH M1 + Dial DTMF M3						
Talk-Around							Recall CH M1 + Dial DTMF M4						
Scan							Recall CH M2 + Dial DTMF M1						
OS/GS Toggle							Recall CH M2 + Dial DTMF M2						
Page (Transpond)							Recall CH M2 + Dial DTMF M3						
Quiet							Recall CH M2 + Dial DTMF M4						
Recall CH M1							Recall CH M3 + Dial DTMF M1						
Recall CH M2							Recall CH M3 + Dial DTMF M2						
Recall CH M3							Recall CH M3 + Dial DTMF M3						
Recall CH M4							Recall CH M3 + Dial DTMF M4						
Speed Dial Selcall Memory							Recall CH M4 + Dial DTMF M1						
Recall CH M1 + Dial Selcall Mem							Recall CH M4 + Dial DTMF M2						
Recall CH M2 + Dial Selcall Mem							Recall CH M4 + Dial DTMF M3						
Recall CH M3 + Dial Selcall Mem							Recall CH M4 + Dial DTMF M4						
Recall CH M4 + Dial Selcall Mem							Call						
Speed Dial DTMF M1							Keylock						
Speed Dial DTMF M2							Monitor (Toggle)						
Speed Dial DTMF M3							S-Meter (Toggle)						
Speed Dial DTMF M4													

**Tick the boxes that match the function keys on your radio with the specific feature programmed by your retailer.**

## STANDARD FUNCTIONS

### TURNING THE TX3800 Series ON OR OFF

Rotate the **Volume** control clockwise past the 'click' to turn the TX3800 Series ON. Rotate the control fully counter clockwise past the click to turn the radio OFF.

**MC522BC**- Press and **hold** the **PWR** key for 2 seconds to turn the unit ON. Press and **hold** the **PWR** key for 2 seconds to turn the unit OFF.

### ADJUSTING THE RECEIVER VOLUME

While receiving a signal, rotate the **Volume** control to achieve a comfortable listening level.

**MC522BC**- While receiving a signal, press the **+** to increase the volume and press the **-** to decrease the volume to achieve a comfortable listening level.

If there are no signals present, press the **SQUELCH** key, briefly to open the squelch, then adjust the volume while

listening to the receiver's background noise. When finished, briefly press the **SQUELCH** key again to return the receiver to the quiet state.

If your radio does not have a SQUELCH key and there are no signals present, set the **Volume** control to the **11 o'clock** position as a starting point.

**MC522BC**- If the radio does not have a squelch key and there are no signals present, set your volume to **12** as a starting point.

**Note:** The minimum setting of the Volume control has been factory preset so that, even with the volume turned right down, you can still hear a low level sound from the speaker).

## SELECTING CHANNELS

The channels in your radio are preprogrammed by your retailer and are Identified by numbers. In addition, each channel may also be programmed with an Identifying name or 'alphanumeric label'. The label appears in the bottom left of the display.

To change channels, rotate the **Channel Selector** knob. Rotating it clockwise will select higher channel numbers while rotating it counterclockwise will select lower channel numbers.

**MCS22BC**- To change channels, press the ▲ and ▼ keys to step upwards or step downwards one or more channels.

### Alphanumeric Labels

As well as Identifying channels by their channel numbers, channels may be programmed with a 5 character alphanumeric label. Using labels with meaningful names makes it much easier to Identify channels.

e.g. The channel you normally contact your office on might be labelled **OFFICE** while a construction site channel might be labelled **SITE1**. In this way you no longer need to remember which channel numbers to select, you simply select the required channel by its label.



Alpha Numeric Label

### MCS22BC OPTION



Alpha Numeric Label

Alphanumeric labels are preprogrammed into your radio by your retailer.

## TRANSMITTING

Before transmitting, check to see if the channel is already in use (i.e. 'BUSY' will be displayed). If the channel is busy, you should wait until it is clear before transmitting.

To transmit, press the **Push-To-Talk (PTT)** switch on the microphone. Hold the microphone about 2 - 6 cms from your mouth and slightly to one side so that you are speaking across the microphone, not directly into it. When talking, speak at a normal voice level. The microphone is quite sensitive so it is not necessary to raise your voice or shout.

**Note:** Your radio may have been programmed to prevent you from transmitting when the channel is already in use. If this is the case, pressing the **PTT** switch while the channel is busy will result in a low beep and the transmitter will not function.

## RECEIVING

### Normal Reception

Your radio will normally be muted (squelched) so that it is quiet when there are no signals. When a transmission is received, the radio will automatically unmute itself to allow you to hear the call.

### The BUSY Indicator

Whenever the channel is active, the 'BUSY' indicator will appear on the display. However, depending on the muting options programmed into your radio, you may not always hear any sound from the speaker. This can happen when others are sharing the channel but their calls are not meant for you. For this reason it is important that you visually check that the channel is not busy before making a call to ensure you do not accidentally talk over someone else. In some cases your radio may be programmed with 'Busy Channel Lockout' to prevent you from transmitting while the channel is busy.

### Signal Meter

The TX3800 Series may be programmed to display the strength of the incoming signal in the lower left of the LCD.



Signal Meter

### MCS22BC OPTION



Signal Meter

## USING THE PROGRAMMABLE FUNCTIONS

The TX3800 Series can be programmed to suit your specific requirements by enabling only those features that are useful to your operation.

The following section describes all the additional features available in the TX3800 Series. In most cases only a few of these features will be enabled in a TX3800 Series at any one time. Many of the front panel keys are able to perform multiple functions depending on how they are programmed. In addition many of the functions can be programmed into more than one key which means that no specific key can be addressed as performing a particular function. It is therefore a matter for your retailer to inform you of the keys that are enabled and what their functions are. You can then refer to this manual to learn how to use the specific functions with which you have been provided. (The table on page 5 is provided to enable you to tick the appropriate boxes to match the 6 function keys with the specific functions programmed by your retailer).

### THE SQUELCH KEY

---

The Squelch (or mute) is used to eliminate any annoying background noise when there are no signals present. The TX3800 Series features a pre-set squelch system which can be switched ON or OFF using the **SQUELCH** key. When the squelch is OFF, the receiver's background noise will be heard (unless Quiet is enabled) and the 'BUSY' indicator will appear on the display. When the squelch is ON, the receiver will remain quiet when there are no signals present, but an incoming signal will overcome the squelch action and be heard in the speaker.

To **disable the squelch**, briefly press the **SQUELCH** key. A low beep will be heard. If there are no signals present, you will hear the receiver's background noise.

To **re-enable the squelch**, briefly press the **SQUELCH** key again. A high beep will be heard.

**Note:** Disabling the squelch will allow you to listen to all other callers on the channel, unless Selcall is in use and the **QUIET** key has been pressed as indicated by the icon on the display.

---

### Setting the Squelch Sensitivity

---

If an incoming signal is very weak and is close to the minimum squelch level, it may become broken or 'chopped' by the squelch action. To prevent this, simply open the squelch to allow the signal to be heard clearly.

Alternatively, you can reduce the squelch sensitivity as described as follows.

The sensitivity of the squelch to incoming signals can be set to suit your operating environment. The TX3800 Series has three preset squelch sensitivity settings which can be selected using a front panel key sequence.

- **SQL1: Maximum Sensitivity**

The squelch will open even on very weak signals. This is the best setting for quiet country or rural locations where there are very few weak stations or little locally generated interference.

- **SQL2: Medium Sensitivity**

The squelch will open on most signals, but will not be as sensitive to very weak signals or local interference. Suitable for general or suburban use.

- **SQL3: Minimum Sensitivity**

The squelch will open on reasonably strong signals and weak signals will not be heard. Suitable for inner city applications or areas of severe interference.

### To pre-select the squelch sensitivity

---

1. Turn your radio OFF at the **Volume** control.  
**MC522BC** - Turn your radio OFF by pressing and holding the **PWR** key for 2 seconds.
2. Hold the **F1** and **F4** keys while turning the unit back ON again.  
**MC522BC** - Hold the **F1** and **F4** keys while pressing and holding the **PWR** key for 2 seconds.
3. Rotate the **Channel Selector** knob to select **SQL1**, **SQL2** or **SQL3**.  
**MC522BC** - Press the ▲ and ▼ keys to select **SQL1**, **SQL2** or **SQL3**.
4. Turn the unit OFF again to store the setting.  
**MC522BC** - Turn the unit OFF by pressing and holding the **PWR** key for 2 seconds to store the setting.

### THE HI/LO POWER KEY

---

The Hi/Lo Power key is used to change the output power of the transmitter from its maximum level of 25 Watts down to 5 Watts. There are a number of reasons why you might want to use low power, including operating in close proximity to other radios or a nearby repeater, or conserving power when operating from a battery supply. If the other radios or the nearby repeater are some distance away, you should select **Hi** power, to ensure maximum range.

**Note:** Some channels on your radio may be permanently programmed for High or Low Power. The Hi/Lo power key will be ignored on these channels.

---

### To select Low Power

Briefly press the **LO Power** key. A low beep will be heard and 'TX LO' will appear momentarily on the lower left of the display.



### MC522BC OPTION



### To return to High Power mode

Briefly press the **LO Power** key again. A high beep will be heard and 'TX HI' will appear momentarily on the lower left of the display.



### MC522BC OPTION



**Note:** The HI or LO power setting of the transmitter will also be displayed when the **PTT** switch is first pressed. If other functions are also active, they may also share the same display area. For example, if Group Scan and Low Power are both selected, the display may indicate 'GS LO' on the lower left of the display.



### MC522BC OPTION



## REPEATERS AND TALK AROUND

### Repeaters

Some of the channels in your radio may be programmed for operation through a repeater system. The repeater is a transmitter/receiver system installed in a high location. It is used to increase the range of your radio by receiving your calls and automatically re-transmitting them. Because your receiver and transmitter will be operating on different channels, you will not be able to talk directly to another radio except through the repeater.

### Talk-Around

The Talk-Around feature is designed to overcome the problem of not being able to talk directly to another radio when a repeater channel is selected. It may be necessary to talk directly to another radio when you are out of range of the repeater. Instead of being isolated and not able to communicate, you can press the **TALK-AROUND** key (if programmed) to force the radio to transmit and receive on the same channel. This will allow you to talk to other radios within direct range of your radio. Of course, the radio you want to talk to must also select TALK-AROUND if they want to talk back to you.

**Note:** The distance over which you can communicate will be much less than it would be through the repeater.

### To select Talk-Around:

Briefly press the **TALK-AROUND** key. A high beep will be heard and 'T/A' will appear on the display. You can now talk to the other radio in the usual way.



## MCS22BC OPTION



### To cancel Talk-Around:

Briefly press the **TALK-AROUND** key again. A low beep will be heard and 'T/A' will disappear from the display.

## CTCSS/DCS

(Continuous Tone Coded Squelch System / Digitally Coded Squelch)

CTCSS/DCS are automatic coded squelch systems that allow groups of radio receivers to remain quiet until they receive a call encoded with a specific squelch tone. The receiver's squelch then opens to allow the call to be heard and closes again when the call is finished. Other radios sharing the same channel but programmed with a different squelch tone will not hear the call. Similarly, calls made to other radios that use a different squelch tone will not be heard by your radio. In this way several groups of radios can share the same channel but be almost unaware of each other's existence. One main advantage of CTCSS/DCS is it is fully automatic with no special operation required by the user.

**Tip:** If using UHF CB channels with CTCSS, the CTCSS tones can be enable or disabled using the SQUELCH key. Whenever CTCSS is enabled on CB channels, the 'SILENT' icon is displayed.



## MCS22BC OPTION

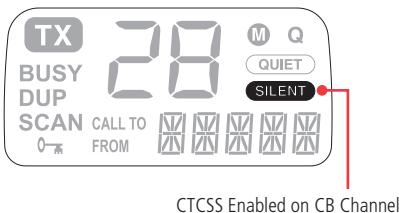

## THE MONITOR KEY

The MONITOR key is used to monitor (listen) to a channel that would normally remain squelched (quiet) under the control of a CTCSS or DCS tone. When CTCSS/DCS is being used, there may be other users talking on the channel (i.e. you will see the 'BUSY' icon appear on the display, but you will not be able to hear anything. Pressing the **MONITOR** key overrides the tone squelch code to allow you to hear these signals. The MONITOR key is often used to check that the channel is clear before transmitting.

### To listen for signals on the channel:

Press and hold the **MONITOR** key to listen for signals on the channel. A high beep will be heard as the key is pressed. The key must be **held down continuously** for the signals to be heard. Release the key to return to quiet operation. You will hear a low beep.

**Note:** Pressing the MONITOR key does not open the Squelch, it simply overrides the CTCSS/DCS tone decoder. If there are no signals on the channel, the radio will still remain quiet and no receiver noise will be heard.

## PROGRAMMING RECALL CHANNELS

Any of the six function keys can be programmed for use as Recall channels. These allow you to select an often-used channel with a single key press. Recall channels can either be preset by the retailer, or made user programmable to allow you to store your own choice of channels. If one or more of these keys are enabled for use as user programmable recall channels, you can program your own channels as follows:

1. Select the channel you wish to store by rotating the **Channel Selector** knob.  
**MCS22BC-** Select the channel you wish to store by pressing the ▲ and ▼ keys.
2. Press and hold the appropriate Channel Recall key (**F1, F2, F3, F4, A or B**). The channel display will flash for a second or so, then the radio will beep. The channel is now stored.
3. Repeat steps 1 and 2 to program any other Channel Recall keys that may be available.

## SELECTING CB CHANNELS

If your radio has been programmed with the Australian UHF Citizen Band Channels, you can select them by simply rotating the **Channel Selector** knob until they appear. CB channels are identified by 'CB' and the associated channel number in the lower left of the display.

**Note:** The power output is limited to 5 Watts on UHF CB channels.

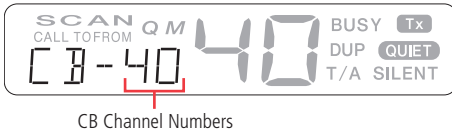

CB Channel Numbers

**MC522BC OPTION**

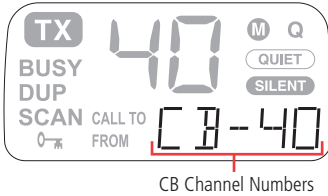

CB Channel Numbers

**SCANNING**

Your retailer may have a scanning feature programmed into your radio. If so, the following section describes how to use this feature.

**OVERVIEW**

The scanning function allows the radio to step through a number of selected channels while searching for signals. If a signal is found, the radio pauses on that channel to allow the signal to be heard. When the signal has gone, the radio resumes scanning for further signals. Exactly how the scanning feature reacts to a signal will depend on the options programmed into your radio.

In the following section, your working channel (sometimes called the Priority channel) is defined as the channel where others would normally expect to be able to contact you and is most probably where you would do most of your communicating.

**SCAN GROUPS**

There are two possible scan groups available. These are called **Open Scan (OS)** and **Group Scan (GS)**. Your radio may be programmed with either one of these groups or it may have both groups programmed.

- Open Scan (OS) allows any of the fitted channels to be scanned in an ascending sequence (i.e. from the lowest channel number to the highest).
- Group Scan (GS) also allows any of the fitted channels to be scanned in an ascending sequence, but in addition, it inserts your main working channel into the scan sequence. Your working channel is then monitored regularly while scanning to ensure that no calls are missed. Any signal received on your working channel has priority and will override any signals received on the other channels.

**Selecting a Scan Group**

If you have been given the option of selecting scan groups, one of the function keys on your radio will be programmed for **OS/GS Toggle**. The current scan group is normally displayed in the lower left of the LCD as 'OS' for Open Scan or 'GS' for Group Scan.

**To change the scan group:**

Briefly press the **OS/GS Toggle** key. A beep will be heard and the display will change to indicate the group you have selected.



Open Scan Mode



Group Scan Mode

**MC522BC OPTION**



Open Scan Mode



Group Scan Mode

**Note:** If the selected channel is displaying an alphanumeric label, pressing the **OS/GS Toggle** key will cause the display to change to 'OS' or 'GS' briefly, before returning to the alphanumeric label.

**Programming your Working (Priority) Channel**

For the purpose of Group Scan, your working channel is usually programmed by your retailer. When programmed, the working channel becomes the channel of priority in the Group Scan mode.

The working channel is normally stored in channel memory No.1. If one of the Function keys on your radio has been programmed to allow recall of channel memory 1 and 'Recall Channel Editing' has been enabled, you can edit the working channel as follows:

1. Press the **Recall Channel Memory 1 Function** key.
2. Select the required working channel using the **Channel Selector** switch.  
**MC522BC-** Select the required working channel by pressing the **▲** and **▼** keys.
3. Press and hold the **Recall Channel Memory 1 Function** key until you hear a beep. The channel display will flash for a moment and the selected working channel will be saved.

## Programming the Scan Channels

Depending on your application, EITHER:

1. Your scan channels will have been pre-programmed for you by your retailer,

**OR**

2. You will have been given the option to program your own group of channels.

If you are able to program your own scan channels, please read the following section.

### To program the scan channels:

1. Select the required scan group using the **OS/GS Toggle** key. (If your radio has alphanumeric labels, refer to the section on changing the scan group on the previous page).
2. Select the required channel using the **Channel Selector** knob.  
**MC522BC**- Select the required channel by pressing the ▲ and ▼ keys.
3. Press and hold the **SCAN** key until a high beep is heard. 'M' will appear on the display to indicate the channel is now stored in memory.
4. Repeat steps 2 and 3 to add other channels to the scan memory.

Indicates selected channel is stored in memory



### MC522BC

Indicates selected channel is stored in memory

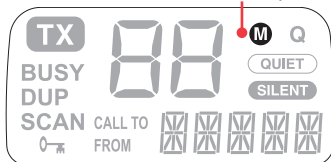

### To remove channels from the scan memory:

1. Select the required scan group – either 'Open Scan' (OS) or 'Group Scan' (GS).
2. Select the required channel using the **Channel Selector** knob. Check that 'M' is displayed indicating that the channel is in the scan memory.  
**MC522BC**- Select the required channel by pressing the ▲ and ▼ keys, 'M' is displayed indicating that the channel is in the scan memory.

3. Press and hold the **SCAN** key until a low beep is heard. 'M' will disappear from the display to indicate the channel is no longer in memory.
4. Repeat steps 2 and 3 to remove other channels from the scan memory

## Selecting Scan

Once you have your selected groups programmed, you can scan the channels in these groups using the SCAN key.

### To begin scanning:

1. Briefly press the **SCAN** key. A high beep will be heard and the radio will begin scanning.
2. Press the **OS/GS Toggle** key (if fitted) to select the required scan group. 'OS' or 'GS' will be displayed.

### To cancel scanning:

Briefly press the **SCAN** key again. A low beep will be heard and the radio will stop scanning.

## Scanning in Open Scan Mode

While scanning in Open Scan mode, the radio will display rapidly changing numbers to indicate the channels being scanned. In addition the lower section of the LCD will display 'OS' (indicating the Open Scan mode is selected), along with the number of the last selected channel. If any channels have alphanumeric labels, the labels will not be displayed while scanning.

### Receiving on a busy channel:

If a signal is received, the receiver will lock onto that channel and will remain there for as long as the channel is busy – and for 5 seconds after the transmission ceases. This allows the TX3800 Series to hold the channel between short breaks in the conversation. Once the channel has remained clear for 5 seconds, the radio will resume scanning

### Skipping over a busy channel:

If you don't wish to listen to a busy channel, you can skip over it by briefly pressing the **SKIP/CALL** key on the microphone. The receiver will immediately resume scanning.

### Holding onto a busy channel:

To manually hold a busy channel, briefly press the **PTT** switch. Scanning will pause and 'M' will be displayed. You can now transmit and receive on that channel in the usual way. 'SCAN' will still be displayed to remind you the SCAN function is only inhibited temporarily.

To resume scanning press the **SKIP/CALL** key on the microphone. 'M' will disappear and scanning will resume.

To cancel scanning, briefly press the **SCAN** key.

- If the radio was stopped on a busy channel when scan was cancelled, it will remain on that channel.

- If the radio was scanning when scan was cancelled, it will return to the last selected channel (as displayed in the bottom right of the display).

### Scanning in Group Scan Mode

---

Scanning in Group Scan mode will allow you to transmit and receive normally on your working (priority) channel but will also let you scan and listen to several other channels when the working channel is free. The receiver will continue to scan the other Group Scan channels ONLY WHILE THERE ARE NO SIGNALS ON THE WORKING CHANNEL. Pressing the **PTT** switch at any time will take you straight to your working channel.

The working channel is normally scanned after every second Group Scan channel (although this can be altered by your retailer).

e.g. Using working channel 10 with group Scan channels 1, 3, 6, 8, 15 and 26.

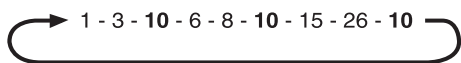

As with the Open Scan mode, your radio will display rapidly changing numbers to indicate the channels being scanned. In addition the lower section of the LCD will display 'GS' to indicate that it is the Group Scan mode, along with the working channel number. If any channels have alphanumeric labels, the labels will not be displayed while scanning.

### Receiving Signals on the Working Channel

---

If a signal appears on the working channel while scanning, the receiver will lock onto the channel and will remain there for as long as the channel is busy – and for 5 seconds after the transmission ceases. This allows the TX3800 Series to hold the channel between short breaks in the conversation. Once the channel has remained clear for 5 seconds, the radio will resume scanning.

If a signal appears on the working channel while your radio is locked onto a Group Scan channel, the receiver will switch straight to the working channel. The receiver will now continue to monitor the working channel for as long as it remains busy. During this time you can transmit on the working channel in the usual way.

### Receiving Signals on a Group Scan Channel

---

If a signal is received on a Group Scan channel, the receiver will lock onto it and will remain there for as long as the channel remains busy, and for 5 seconds after the transmission ceases – AS LONG AS THERE ARE NO SIGNALS ON THE WORKING CHANNEL. During this time, the receiver will continue to check for signals on the working channel every couple of seconds resulting in a series of small breaks in the reception of the 'locked' channel. If no signals are heard on the 'locked' channel after 5 seconds, the radio will resume normal scanning.

To stay on a busy Group Scan channel, briefly press the **SCAN** key. The radio will exit the SCAN mode and stay on the busy channel. You can now transmit normally on that channel.

**Note:** At this point the radio will no longer be monitoring your working channel.

To resume Group Scan briefly press the **SCAN** key again.

## SELECTIVE CALLING

If Selcall has been enabled on your radio, it will have been pre-programmed with its own unique Identifying code. Your radio may also allow you to transmit Selcall codes, allowing you to call others who are also using the Selcall system.

Selective Calling is a secure signalling system that allows individual radios to be selectively called without disturbing other radios sharing the same channel. Each radio can be pre-programmed with a unique code (called a Selcall Ident). The radio can then be set to remain totally quiet while it monitors the channel for Selcall signals. Any incoming Selcall code is compared with its own code. If the two codes match, it knows it is being called and sounds an alarm to alert you. It also displays the caller's unique code or an alphanumeric label Identifying the caller to you. In this way, even if you are away from your radio when the call is received, you will still know that you were called. You can then return the call at your convenience. If further calls are received, the most recent caller is displayed.

A special group code may also be available to you which will allow specific groups of radios to be selectively called without disturbing other individuals or groups.

### OPERATING IN THE QUIET MODE

---

The QUIET mode prevents any incoming transmissions from being heard in your TX3800 Series speaker until your Selcall Ident is received. This allows you to monitor a busy channel for calls without being disturbed by unwanted signals.

When your Selcall Ident is received, the QUIET mode is cancelled and all incoming signals will be heard in the speaker.

If your radio is programmed with a QUIET key, you will be able to manually set your receiver's Selcall Quiet muting system. If not, your radio's quiet muting system will have been preset for you by your retailer.

#### The QUIET key

---

If fitted, the QUIET key can be used with Selcall to enable or disable quiet operation.

- When Quiet is enabled, you will not hear any signals on the channel until someone specifically calls you using Selcall.

- When Quiet is disabled, you will be able to hear all transmissions on the channel.
- When Quiet is enabled, you will see the 'QUIET' icon on the display.



Quiet is enabled in this channel

### MC522BC OPTION

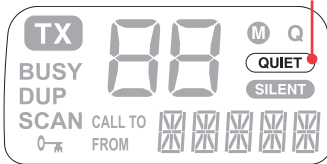

Quiet is enabled in this channel

Your radio may be programmed to allow you to select those channels you wish to use as quiet channels. This is done by tagging the channels that you want to stay Quiet. Then, when QUIET is activated, the channels you have tagged will remain Quiet to all incoming signals. Channels not tagged will operate normally. The QUIET key is also used to tag these channels.

### To tag a channel for use in the QUIET mode:

1. Select the required channel using the **Channel Selector** knob.  
**MC522BC-** Select the required channel by pressing the ▲ and ▼ keys.
2. Press and hold the **QUIET** key until a high beep is heard.

The 'Q' icon will appear on the display, indicating that the selected channel is now tagged for use with Selcall in the quiet mode.



Selected channel is tagged for QUIET mode

### MC522BC OPTION



Selected channel is tagged for QUIET mode

3. Repeat steps 1 and 2 to tag any other channels.

### To activate the QUIET mode:

1. Select a channel which has been tagged for quiet operation ('Q' will be visible on the display).
2. Briefly press the **QUIET** key.

A high beep will be heard and the 'QUIET' icon will appear on the display.

Now all channels that have been tagged for quiet operation will stay quiet unless a Selcall is received. Channels that are not tagged will still allow all signals to be heard.

**Note:** You cannot activate the QUIET mode unless you have selected a 'tagged' channel with 'Q' displayed.

### To de-activate the QUIET mode:

1. Select a channel that has been tagged for quiet operation ('Q' and 'QUIET' will be visible on the display).
2. Briefly press the **QUIET** key. A low beep will be heard and 'QUIET' icon will disappear from the display and all channels tagged for Quiet operation will now operate normally again.

### To Remove the QUIET Tagging:

1. Select a channel that has been tagged for Quiet operation. 'Q' will be displayed to the upper left or upper right (MC522BC) of the channel number.
2. Press and hold the **QUIET** key until a low beep is heard. The 'Q' icon will disappear from the display, indicating that the selected channel is no longer tagged for use with Selcall in the QUIET mode.

### Receiving Signals in the QUIET Mode:

- If a normal signal is received on a QUIET channel, the channel will appear busy but no sound will be heard from the speaker. This means you will not be disturbed by the signal.
- If a normal signal is received on an Open channel (one that is not tagged with 'Q') the signal will be heard in the usual way.
- If a signal containing your Selcall Ident is received on any channel – Open or Quiet – the QUIET mode will be cancelled and the alarm will beep to alert you to the call. In addition, the callers Ident or Name will be displayed. All channels will now be open for normal transmission and reception.

### Scanning in the Quiet Mode

The TX3800 Series may be programmed to allow you to scan while the QUIET mode is active. You can then monitor a group of Quiet channels or a combination of Quiet and Open channels.

### To Scan in the QUIET Mode:

1. Press the **OS/GS Toggle** key to select the required Scan group (if available).
2. Select the channels you wish to remain Quiet and tag each one with 'Q'.
3. With a tagged channel selected, briefly press the **QUIET** key to activate the QUIET Mode.
4. Now press the **SCAN** key. The radio will begin scanning and 'SCAN' will be displayed.
  - If a normal signal is received on an open channel, scanning will pause while the channel is busy and will resume scanning 5 seconds after the channel becomes clear. (If you were scanning in GS mode, the radio may switch between the open channel and the Priority channel. This is normal).
  - If a normal signal is received on a Quiet channel but your Selcall Ident is not detected, the signal will be ignored and scanning will continue.
  - If a signal containing your Selcall Ident is received on any channel – Open or Quiet – both SCAN and QUIET modes will be cancelled and the receiver will stay on that channel. In addition, the alarm will beep to alert you to the call and the callers Ident will be displayed. The channel will now be open for normal transmission and reception.

**Note:** To ensure reliable Selcall detection when scanning, it is recommended that you restrict the number of channels in the Scan group.

In Open Scan Mode: 10 Channels

In Group Scan Mode: 8 Channel plus the Priority Channel

### SENDING A SELCALL

There are several ways to make a Selcall transmission. The method you use will depend on the options programmed into your radio.

#### Sending a Selcall using the Selcall Speed Dial memories

Selcall 'Speed dial' memories are used when your radio has been preprogrammed with the necessary Selcall codes for your group, with no provision to manually alter them.

Speed Dial memories are programmed into one or more of the function keys.

To send a Selcall using a Speed Dial memory, press and hold the appropriate key (**F1, F2, F3, F4, A** or **B**) for a few seconds until a beep is heard. The 'TX' indicator will be displayed as the Selcall code is sent.

If your Selcall is successful, you will hear two quick beeps in the speaker. This is an acknowledge signal, sent back to you from the radio you called. It is used to confirm that your Selcall was received.

#### Sending a Selcall using the Selcall Speed Dial memories with Channel Recall

Your Speed Dial memories may have been programmed to recall a specific channel before sending the Selcall.

To send a Selcall using a Speed Dial memory programmed with Channel Recall, simply press and hold the appropriate key (**F1, F2, F3, F4, A** or **B**) for a few seconds until a beep is heard. The radio will change to the preprogrammed channel, and the 'TX' indicator will be displayed as the Selcall code is sent. The radio will then stay on the preprogrammed channel.

If your Selcall is successful, you will hear two quick beeps in the speaker. This is an acknowledge signal, sent back to you from the radio you called. It is used to confirm to you that your Selcall was received.

#### Sending a Selcall using the preprogrammed Call To Selcall memories

Your radio has provision to hold up to 40 preprogrammed Selcall Idents in its Call To memory. These memories are likely to have been preprogrammed by your retailer. However, provision may have been given to allow you to edit these memories yourself.



Selcall label displayed in Alpha Mode

#### MCS522BC OPTION



Selcall label displayed in Alpha Mode

#### If the Call To memories are available, you can select them as follows:

1. Briefly press the **CALL** key. 'Call To' will appear on the display, along with the Selcall Ident for memory location A. If the radio is in Alpha mode, the Ident may display a label representing the Ident instead of the Ident number.

**Note:** If no user input is detected for 20 seconds, the radio will return to normal mode and you will have to begin again.

2. Rotate the **Channel Selector** knob to step through the available Selcall memories. The selected selcall memory number is displayed in the channel display area.  
**MC522BC**- Press the ▲ and ▼ keys to step through the available selcall memories. The selected selcall memory number is displayed in the channel display area.
3. If there are Alpha labels associated with the Selcall Idents, you can switch between Alpha and Numeric display modes by briefly pressing the **Volume** knob. 'ALPHA' or 'NUMER' will appear briefly in the selcall display area to indicate the selected mode.  
**MC522BC**- If there are Alpha labels associated with the Selcall Idents, you can switch between Alpha and Numeric display modes by briefly pressing the **B** key. 'ALPHA' or 'NUMER' will appear briefly in the selcall display area to indicate the selected mode.

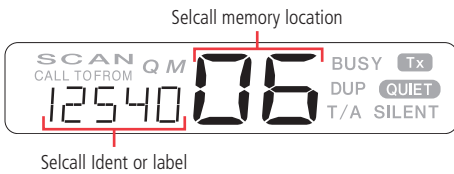

#### MC522BC OPTION

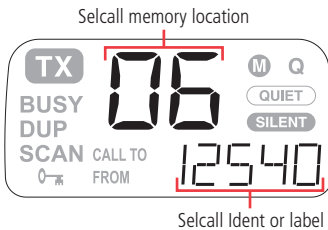

To transmit the selected Selcall Ident while in the Call To mode, press and hold the **CALL** key for a few seconds until a beep is heard. The 'TX' indicator will appear on the display and the selected selcall will be transmitted. The radio will then return to normal operation.

**Note:** Of the 40 available memory locations, 1 thru 38 are available for user defined or preprogrammed Selcall memories. Location 39 contains the Pager Ident. If the Pager feature is disabled, then this memory location is also available as a user defined memory. Location 40 is reserved for the 'last-sent' selcall Ident and is not editable.

### Editing the Preprogrammed Call To Selcall Memories

If your retailer has enabled Selcall Memory Editing on your radio, you can program and store your own Selcall Ident memories and associated Alpha labels as follows.

**Tip:** The memory is programmed in two stages with the Numeric Ident being programmed first, followed by the

Alpha label if required. Each memory should be programmed in one continuous process. If no user input is detected for 20 seconds, the radio will return to normal mode and you will have to begin again.

1. Briefly press the **CALL** key. 'Call To' will appear on the display, and the Selcall Ident for memory location 1 will be displayed. If the radio is in Alpha mode, the radio may display a label representing the Ident instead of the Ident number itself. If there is no label programmed, the selcall display area will be blank when in Alpha mode.
2. Rotate the **Channel Selector** knob to select the required Selcall memory. The selected selcall memory number is displayed in the channel display area.  
**MC522BC**- Press the ▲ and ▼ keys to select the required Selcall memory. The selected selcall memory number is displayed in the channel display area.
3. Briefly press the **Volume** knob to select the Numeric mode. 'NUMER' will appear briefly in the Selcall display area when Numeric mode is selected.  
**MC522BC**- Briefly press the **B** key to select the Numeric mode. 'NUMER' will appear briefly in the Selcall display area when Numeric mode is selected.

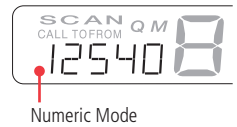

#### MC522BC OPTION

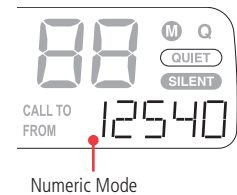

- 4 To enter the EDIT mode, press and hold the **Channel Selector** knob until a beep is heard. 'EDIT' will appear briefly in the selcall display area and the right hand selcall digit will begin flashing.  
**MC522BC**- To enter the EDIT mode, press and hold the **A** key until a beep is heard. 'EDIT' will appear briefly in the selcall display area and the right hand selcall digit will begin flashing.
5. Rotate the **Channel Selector** knob to alter the flashing digit. When the correct digit is displayed, briefly press the **Channel Selector** knob to move to the next digit. Continue the process until the required Selcall Ident is displayed.  
**MC522BC**- Press the ▲ and ▼ keys to alter the flashing

digit. When the correct digit is displayed, briefly press the **A** key to move to the next digit. Continue the process until the required Selcall Ident is displayed.

- Now press and hold the **Channel Selector** knob again to store the Ident. All the digits will flash, then the radio will beep and 'SAVED' will appear briefly in the selcall area.  
**MC522BC**- Now press and hold the **A** key again to store the Ident. All the digits will flash, then the radio will beep and 'SAVED' will appear briefly in the selcall area.
- To program an Alpha Label, briefly press the **Volume** Knob. 'ALPHA' will appear briefly in the selcall area.  
**MC522BC**- To program an Alpha Label, briefly press the **B** key. 'ALPHA' will appear briefly in the selcall area.
- Enter the EDIT mode again by pressing and holding the **Channel Selector** knob until a beep is heard. 'EDIT' will appear briefly in the selcall display area.  
**MC522BC**- Enter the EDIT mode again by pressing and holding the **A** key until a beep is heard. 'EDIT' will appear briefly in the selcall display area.
- Rotate the **Channel Selector** knob to select the 'rightmost' character of the label you wish to enter. When done, briefly press the **Channel Selector** knob to move left to the next character position. Continue the process until the required label is displayed. Up to 5 characters can be entered.  
**MC522BC**- Press the **A** key to select the 'rightmost' character of the label you wish to enter. When done, briefly press the **A** key to move left to the next character position. Continue the process until the required label is displayed. Up to 5 characters can be entered.
- Now press and hold the **Channel Selector** knob again to store the Label. All the characters will flash, then the radio will beep and 'SAVED' will appear briefly in the selcall area.  
**MC522BC**- Now press and hold the **A** key again to store the Label. All the characters will flash, then the radio will beep and 'SAVED' will appear briefly in the selcall area.

Briefly press the **CALL** key again (or wait 20 seconds) to return to normal mode.

The following characters can be selected in the Alpha mode:

\* + - 0 1 2 3 4 5 6 7 8 9 A B C D E F  
G H I J K L M N O P Q R S T U V W X Y Z <SPACE>

## Sending individual Selcalls:

If this feature is available, you can enter and send individual selcall codes without the need to store or retrieve them from the memory.

- Briefly press the **CALL** key. 'Call To' will appear on the display, along with the Selcall Ident for memory location 1.
- If the radio is in Alpha mode, briefly press the **Volume** knob to select the Numeric mode. 'NUMER' will appear briefly in the selcall display area to indicate the selected mode.  
**MC522BC**- If the radio is in Alpha mode, briefly press the **A** key to select the Numeric mode. 'NUMER' will appear briefly in the selcall display area to indicate the selected mode.
- Press and hold the **Channel Selector** knob until a beep is heard. 'EDIT' will appear briefly in the selcall display area and the right hand selcall digit will begin flashing.  
**MC522BC**- Press and hold the **B** key until a beep is heard. 'EDIT' will appear briefly in the selcall display area and the right hand selcall digit will begin flashing.
- Rotate the **Channel Selector** knob to alter the flashing digit. When the correct digit is displayed, briefly press the **Channel Selector** knob to move to the next digit. Continue the process until the required Selcall Ident is displayed.  
**MC522BC**- Press the **B** key to alter the flashing digit. When the correct digit is displayed, briefly press the **B** key to move to the next digit. Continue the process until the required Selcall Ident is displayed.
- Now press and hold the **CALL** key to transmit the Selcall code. The 'TX' indicator will appear on the display as the Selcall code is sent.

**Note:** You must send the Selcall code within 20 seconds of the last key press otherwise the Call To mode will be cancelled and the code will be lost.

If your Selcall is successful, you will hear two quick beeps in the speaker confirming to you that your Selcall was received.

## GROUP SELCALLS

Your TX3800 Series Selcall system may have been programmed with a Group Call function. Group Calling can allow you to call groups of up to 10 radios, or groups of up to 1000 radios simultaneously, depending on how your radio is programmed. This could be useful in an emergency situation where you may need to transmit a message to a number of radios in your group.

The Group Call function works by allowing you to enter a special group code into the last digit positions of the Selcall Ident you are sending. The group code appears as

an 'A' when displayed in the radio. When this group code is received, it substitutes for any other number in the last digit positions. As long as the first digits of the Selcall you are sending match those of the radios you are calling, their Selcall alarms will be activated as if their full 5 digit Selcall Idents had been received.

To achieve this, the radios you are calling must be programmed with sequentially numbered Selcall Idents.

e.g. For groups of 10 radios, the Selcall Idents might be:  
**12030, 12031, 12032, 12033 . . --> , 12039.**

Transmitting the Selcall Ident **12031** will only activate the alarm in the radio with the Selcall Ident of **12031**.

- However, transmitting **1203A** will activate the alarms in all radios with Idents **12030** through **12039** (a total of 10 radios).

Similarly, if there were 1000 radios in the group, simply insert **A** into the last THREE digit positions of the Selcall code you are sending. This will substitute for any numbers in the last THREE digit positions.

i.e. Transmitting **12AAA** would activate all radios with Selcall Idents of **12000** thru **12999**.

If the radios in your fleet do not have sequentially numbered Selcall Idents and you want to make use of this function, you can arrange for your retailer to re-program your radios.

### Programming and Sending Group Calls

If your radio is fitted with Group calling, you can make group calls as follows:

1. Briefly press the **CALL** key. 'Call To' will appear on the display, along with the Selcall Ident for memory location 1.
2. If the radio is in Alpha mode, briefly press the **Volume** knob to select the Numeric mode. 'NUMER' will appear briefly in the selcall display area to indicate the selected mode.  
**MC522BC-** If the radio is in Alpha mode, briefly press the **B** key to select the Numeric mode. 'NUMER' will appear briefly in the selcall display area to indicate the selected mode.
3. Press and hold the **Channel Selector** knob until a beep is heard. 'EDIT' will appear briefly in the selcall display area and the right hand selcall digit will begin flashing.  
**MC522BC-** Press and hold the **B** key until a beep is heard. 'EDIT' will appear briefly in the selcall display area and the right hand selcall digit will begin flashing.
4. Rotate the **Channel Selector** knob to alter the right hand flashing digit. Set this digit to '**A**'. Now briefly press the **Channel Selector** knob to move to the next digit. If you are calling groups of up to 1000 radios, set

this third digit to '**A**' too, otherwise select the required digit. Continue the process until the required Selcall Ident is displayed.

**MC522BC-** Press the ▲ and ▼ keys to alter the right hand flashing digit. Set this digit to '**A**'. Now briefly press the **A** key to move to the next digit. If you are calling groups of up to 1000 radios, set this third digit to '**A**' too, otherwise select the required digit. Continue the process until the required Selcall Ident is displayed.



Calling up to 1000 radios

### MC522BC OPTION



Calling up to 1000 radios

### To Send the Selcall Ident:

With the required Selcall Ident displayed in the 'CALL TO' mode, press and hold the **CALL** key to transmit the Selcall code. The 'TX' indicator will appear on the display as the Selcall code is sent.

**Note:** You must send the Selcall code within 20 seconds of the last key press otherwise the Call To mode will be cancelled and the code will be lost.

### Call Acknowledge in Group Mode:

There is no call acknowledge when sending group calls. This is to prevent all the radios in your group from trying to respond to your Selcall transmission at the same time.

### Storing group Call Idents:

Group Call Idents can be stored in memory in the same way as a standard Selcall Ident.

Simply follow the instructions for storing Selcall Idents in memory as described earlier in this manual.

### Receiving Group Calls:

Receiving a Group call is identical to receiving a normal Selcall except that the alarm sound is a Low tone beep instead of the normal High tone beep. The Callers Ident or Name appears on the display in the usual way.

## DTMF (DUAL TONE MULTIPLE FREQUENCY)

DTMF signaling can be used for dialling telephone numbers or activating devices by remote control. If DTMF is available on your radio, the method you will use to send DTMF signals will depend on the options programmed.

### Using the DTMF Speed Dial memories

DTMF Speed Dial memories are used when your radio has been preprogrammed with the necessary DTMF tone sequences for your application, with no provision to manually alter them.

DTMF Speed Dial memories may be programmed into one or more of the function keys (**F1**, **F2**, **F3**, **F4**).

To send a DTMF signal using a Speed Dial memory, press and hold the appropriate function key (**F1**, **F2**, **F3**, **F4**) until a high beep is heard. The 'TX' indicator will appear on the display as the DTMF tone sequence is sent.

### Using the DTMF Speed Dial memories with Channel Recall

Your DTMF Speed Dial memories may also have been programmed to automatically go to a specific channel before sending your DTMF signal.

To send a DTMF signal using a Speed Dial memory programmed with Channel Recall, press and hold the appropriate function key (**F1**, **F2**, **F3**, **F4**) until a high beep is heard. The radio will change to the preprogrammed channel and the 'TX' indicator will appear on the display as the DTMF signal is sent. The radio will then stay on the preprogrammed channel.

On the MC540, the '\*' and '#' are permanently assigned to DTMF memory 5 and DTMF memory 4 respectively.

### Alarm Input

The 'alarm input' is an interface on the TX3800 Series which can be used to monitor an external contact closure and send a pre-programmed selcall on a designated channel when the input becomes active. In this case, the radio will commence an Alarm Cycle:

1. Hold the radio supply voltage 'ON' (if not already on)
2. Show 'ALARM' on the display
3. Jump to the designated 'Page' channel
4. Transmit a pre-programmed selcall ID a specified number of times. If 'append ANI' is selected, the radio's own ID will be appended to this selcall.

If the radio power was ON when the alarm input was triggered, the radio will return to the previous operating channel but the 'ALARM' state remains latched, i.e. no further alarm cycles can be initiated.

To clear the ALARM state, simply **press any key** on the radio or the microphone.

If the radio power was OFF when the alarm was triggered, the radio will complete the Alarm Cycle and turn itself OFF at the end. In this case, the alarm input can trigger a new Alarm Cycle at a later time.

### Alarm Output

The alarm output port is an open collector output capable of driving an external signalling device - typically a horn, or a flashing light. If enabled, the alarm output will become active when the radio receives an individual or a group selcall, or if the special \*ALRM selcall ID string is matched during a selcall lookup.

The exact alarm output sequence, i.e. the number and duration of relay closures, is fully programmable.

## PAGE MODE

If enabled by your retailer, the PAGE or transpond feature allows you to leave your radio unattended yet still be informed of any incoming Selcalls. If your Selcall Ident is received while your TX3800 Series is in the PAGE mode, it will automatically call another UHF radio to alert you to the call.

**Note:** To allow your TX3800 Series to operate in the PAGE mode when your vehicle is unattended, your radio must be wired so that it has a continuous 13.8 Volt power source.

### Selecting the Paging Channel

Your TX3800 Series Paging channel is pre-programmed by your retailer.

### Selecting the Paging Ident

The PAGE Ident is the Ident of the receiver you will use to receive the paging call. Depending on your requirements, the Paging Ident may be fixed by your retailer, or provision may have been given for you to program it yourself. It is programmed in the same way as Selcall Idents and is stored in Selcall memory 39.

### To program the Paging Ident:

1. Briefly press the **CALL** key on the microphone. 'Call To' will appear on the display, and the Selcall Ident for memory location 1 will be displayed. If the radio is in Alpha mode, the Ident may display a label representing the Ident instead of the Ident number itself. If there is no label programmed, the selcall display area will be blank when in Alpha mode.
2. Rotate the **Channel Selector** knob to select Selcall memory 39. The selected selcall memory number is displayed in the channel display area. If Alpha mode is selected, 'PAGER' will be displayed in the Selcall area.  
**MC522BC-** Press the ▲ and ▼ keys to select Selcall memory 39. The selected selcall memory number is

displayed in the channel display area. If Alpha mode is selected, 'PAGER' will be displayed in the Selcall area.

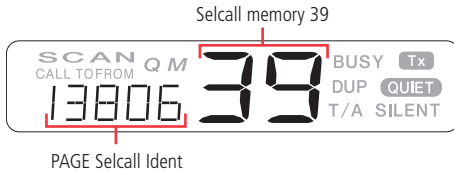

#### MC522BC OPTION

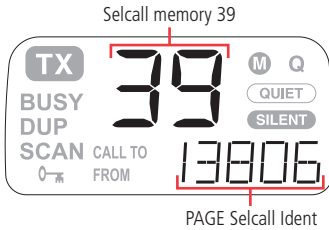

- Briefly press the **Volume** knob to select the Numeric mode. 'NUMER' will appear briefly in the Selcall display area when Numeric mode is selected.  
**MC522BC-** Briefly press the **B** key to select the Numeric mode. 'NUMER' will appear briefly in the Selcall display area when Numeric mode is selected.
- To enter the **EDIT mode**, press and hold the **Channel Selector** knob until a beep is heard. 'EDIT' will appear briefly in the selcall display area and the right hand selcall digit will begin flashing.  
**MC522BC-** To enter the **EDIT mode**, press and hold the **A** key until a beep is heard. 'EDIT' will appear briefly in the selcall display area and the right hand selcall digit will begin flashing.
- Rotate the **Channel Selector** knob to alter the flashing digit. When the correct digit is displayed, briefly press the **Channel Selector** knob to move to the next digit. Continue the process until the required Selcall Ident is displayed.  
**MC522BC-** Press the **▲** and **▼** keys to alter the flashing digit. When the correct digit is displayed, briefly press the **A** key to move to the next digit. Continue the process until the required Selcall Ident is displayed.
- Now press and hold the **Channel Selector** knob again to store the Ident. All the digits will flash, then the radio will beep and 'SAVED' will appear briefly in the selcall area.  
**MC522BC-** Now press and hold the **A** key again to store the Ident. All the digits will flash, then the radio will beep and 'SAVED' will appear briefly in the selcall area.

#### Viewing the Page Ident Memory:

To view the Ident or Name stored in the page memory:

- Briefly press the **CALL** key on the microphone. 'Call To' will appear on the display, and the Selcall Ident for memory location 1 will be displayed.
- Rotate the **Channel Selector** knob to select Selcall memory 39. The selected selcall memory number is displayed in the channel display area. If Alpha mode is selected, 'PAGE' will be displayed in the Selcall area.  
**MC522BC-** Press the **▲** and **▼** keys to select Selcall memory 39. The selected selcall memory number is displayed in the channel display area. If Alpha mode is selected, 'PAGE' will be displayed in the Selcall area.

#### Activating the PAGE Mode:

Select the Page mode by briefly pressing the **PAGE** function key on your radio.

'PAGE' will be displayed in the Selcall area and the display lighting will extinguish after 10 seconds to conserve power in case the radio is to be left in Page mode for an extended period. This also makes the radio less visible if it is left in an unattended vehicle at night.

#### Deactivating the PAGE Mode:

To de-activate the page mode, briefly press the **PAGE** function key again.

#### Receiving your Selcall in PAGE Mode:

If your TX3800 Series receives its own Selcall Ident while in the PAGE mode, it will temporarily switch to the paging channel, check that the channel is not in use, then transmit the paging Ident to the other receiver. It will then return to the channel on which the original call was received, activate its own Selcall alarm and display the caller's Ident.

Meanwhile the other receiver will be beeping to tell you that someone has called you. You can then return to your radio, identify the caller's Ident and return the call.

The PAGE mode can be used either while monitoring a single channel or while scanning in open scan or group scan mode.

#### Monitoring a Single channel in the PAGE Mode:

To monitor a single channel in the PAGE mode, simply select the channel you wish to monitor, then select the Page mode by holding the **CALL** key down and pressing the **Channel Selector** knob.

**MC522BC-** To monitor a single channel in the PAGE mode, simply select the channel you wish to monitor, then select the Page mode by holding the **CALL** key and pressing the **A** key.

With the PAGE mode selected, the radio will operate normally and you can transmit and receive on the selected channel.

- If the selected channel has been tagged for Quiet operation, the QUIET mode will be automatically selected and 'QUIET' will be displayed. In this case, you will not be able to transmit.

- If your Selcall Ident is received, your TX3800 Series will send an acknowledge beep back to the caller then change to the Paging channel and transmit the Page Ident. It will finally return to the selected channel, sound the alarm and display the Ident or Name of the caller.

### Scanning in the PAGE Mode

To Scan in the Page mode, simply select the required scan group, program the required channels, then briefly press the **SCAN** key. The radio will begin scanning.

Now select the PAGE mode by holding the **CALL** key and pressing the **Channel Selector** knob.

**MC522BC**- Now select the PAGE mode by holding the **CALL** key and pressing the **A** key.

### To Return a Call in the PAGE Mode

If you return to your radio and it is beeping, briefly press the **Channel Selector** knob. The radio will exit the PAGE mode and 'CALL FROM' will be displayed along with the Ident or Name of the caller.

**MC522BC**- If you return to your radio and it is beeping, briefly press the **A** key. The radio will exit the PAGE mode and 'CALL FROM' will be displayed along with the Ident or Name of the caller.

Briefly press the **CALL** key. 'CALL TO' will be displayed along with the Ident or Name of the caller. Now press and hold the **CALL** key for a few seconds until the radio beeps. The callers Selcall Ident will be sent. If the call is successful, you will hear two quick acknowledge beeps in your radio's speaker as the caller's radio responds.

## CTCSS/DCS

CTCSS (Continuous Tone Coded Squelch System) and DCS (Digitally Coded Squelch) is a quieting system that allows a group of radios to talk to each other without hearing other users on the channel. The system applies a continuous low level tone to your transmission, and a matching tone decoder to your receiver's squelch. When CTCSS/DCS is enabled the channel remains quiet until someone transmits using the same tone. When the transmission ends, the channel becomes quiet again. By using different tones, several groups of people can share the same channel without disturbing each other.

If CTCSS/DCS has been enabled by your retailer, it will have been preset on specific channels.

## INSTALLATION

The TX3800 Series is supplied with a slim, slide-on mounting cradle. The cradle can be screwed or bolted in any convenient location in your vehicle (under or above the dash, on the centre console, etc) using the mounting slots provided in the base. The TX3800 Series contains a built-in speaker and can be installed with the speaker facing upwards or downwards to ensure the receiver audio is projected clearly. Alternatively, the TX3800 Series can be fitted with an extension speaker if required.

When installing the radio, avoid mounting it close to heaters or air conditioners. Screw the mounting cradle to a firm surface. Slide the TX3800 Series into the cradle from the front until it clicks into place. Finally, plug the power and antenna leads to the sockets provided on the rear of the radio.

### Fitting RH003 Remote Head

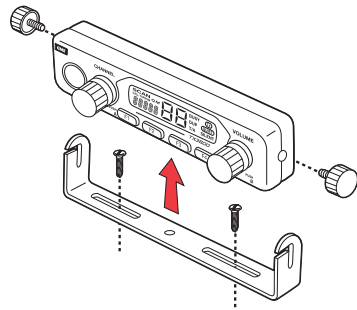

### Mounting the Cradle

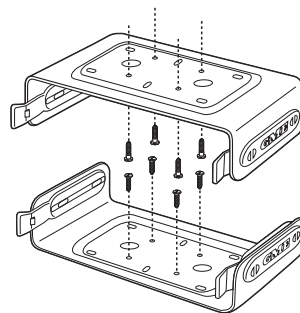

## Fitting MC522BC Microphone

Screw the LCD Controller Microphone and the clip to a firm surface. Position the LCD Controller Microphone in its mounting clip. Finally, plug the LCD Controller Microphone into the front panel. An additional 1.8 m extension cable is supplied to allow more remote mounting of the main unit.

Slide Microphone into the mounting clip

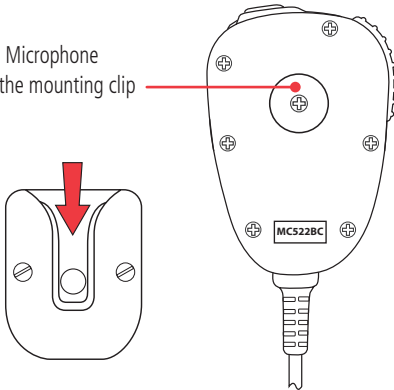

## Fitting the Radio

Slide radio fully into cradle until it clicks into place.

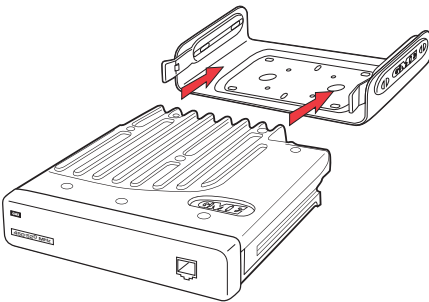

## Removing the Radio

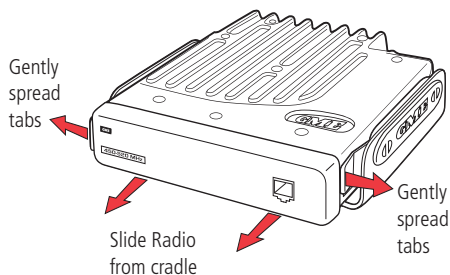

## Fitting the Microphone

The microphone uses a miniature 6 pin telephone style plug and socket. To fit the microphone:

1. Position the microphone plug so the plastic tab faces downwards. Press the plug into the socket until it 'clicks'.
2. Gently press the rubber strain relief into the hole surrounding the socket so that the slot around the strain relief fits neatly inside the lip of the hole.

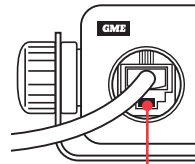

Fitting Mic to front panel

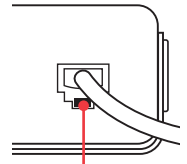

Fitting MC522BC to TX3800 Series

## Removing the microphone

1. Squeeze the rubber strain relief near the front panel to disengage the slot, and slide the strain relief back along the microphone cord.
2. Squeeze the plastic tab on the microphone plug towards the plug to unlock it while gently pulling the plug outwards. If the plug does not come out easily, the tab has not released correctly and should be squeezed again.

## Console Mounting the TX3800 Series

For console mounting, a flush mounting DIN Adaptor MBD001 is available as an optional accessory. The adaptor includes mounting brackets and a specially designed front panel escutcheon to suit most vehicle installations. Installation instructions are provided with the bracket. See your nearest GME retailer for details.

### Din Adaptor MBD001

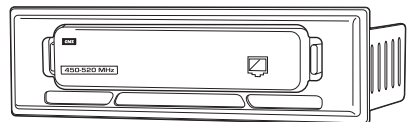

## DC POWER CONNECTION

The TX3800 Series is designed for 13.8 Volt DC, negative earth installations only (i.e. where the negative terminal of the battery is connected to the chassis or frame of the vehicle).

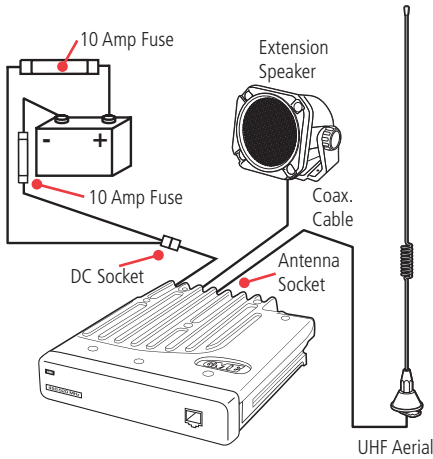

Two inline 10 Amp fuses are supplied. These fuses are to be connected as close to the battery as possible. The radio's positive (red) lead should be connected via a 10 Amp fuse directly to the battery's positive terminal.

Connect the radio's negative (black) lead via a 10 Amp fuse directly to the battery's negative terminal.

## ANTENNA CONNECTION

GME supply a wide range of mobile antennas designed specifically for UHF commercial communications.

The antennas are fitted with a BNC coaxial plug suitable for connection to the antenna socket on the rear panel of the radio.

## OPTIONAL MICROPHONE

### MC540BC Microphone

Available with RH003 remote head option only.

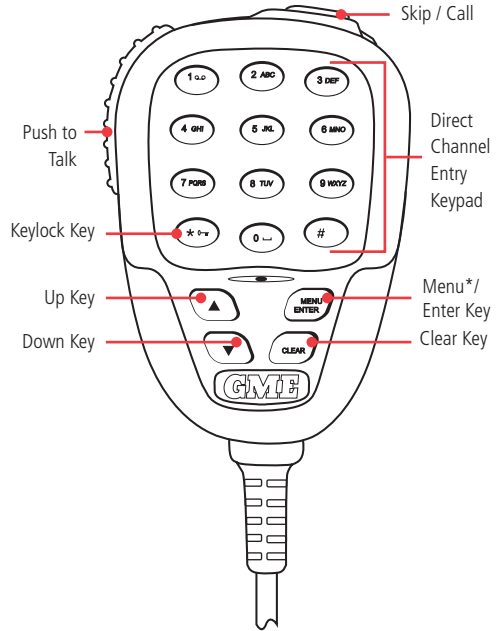

**\*Note:** The Menu key is reserved for future use. Currently no functionality with the TX3800 Series.

## SPECIFICATIONS

### Electrical

#### General

RF Performance:	Compliant with AS/NZS 4295
Frequency Band:	UHF- 450 to 520 MHz or VHF- 136 to 174 MHz
RF Switching Bandwidth:	UHF- 70 MHz VHF- 38 MHz
Number of Channels:	99 (+ 40 UHF CB on UHF Model)
Channel Spacing:	25 kHz / 12.5 kHz
Channel Steps:	12.5 kHz, 6.25 kHz, 5 kHz
Frequency Stability:	$\pm 1$ kHz for $-10^{\circ}\text{C}$ to $60^{\circ}\text{C}$
Modulation:	FM
Operation Mode:	Simplex or half duplex with repeater talk around.
Scanning Speed:	50 / 100 / 200 ms per channel
Antenna Impedance:	50 Ohms nominal
Antenna Connector:	BNC
Battery Voltage:	13.8 Volts DC Negative Earth
Operating Voltage Range:	10.8 Volts to 15.6 Volts
Reverse Voltage Protection:	Diode
Over Voltage Protection:	18 Volts Crowbar
Fuse:	2 x 10 Amp blade type in line fuse.
Current Consumption :	RX muted- 0.2 Amps (power save 60 mA). RX full audio: 0.8 Amps TX- 6.0 Amps (UHF) 5.0 Amps (VHF)

#### Transmitter

RF Output:	High- 25 Watts Max. Low- 5 Watt Adj.
Transmit Duty Cycle:	1:4 for 25 Watt output (1 Min TX, 4 Min RX).
Deviation Limiting:	5 kHz / 2.5 kHz at +20 dB AF limiting (WB/NB).
TX Audio Frequency Response:	+6 dB / octave, +1 dB / -3 dB, 300 Hz to 3 kHz / 2.55 kHz (WB/NB).
AF Distortion:	3% below limiting
Residual Noise & Hum:	-40 dB

Spurious Emissions:	-36 dBm
Adjacent Channel Power:	-70 dBc / -60 dBc (WB/NB)

#### Receiver

Circuit Type:	Double Conversion Superheterodyne.
Intermediate Frequencies:	UHF- 38.85 MHz / 450 kHz VHF- 21.4 MHz / 450 kHz
Sensitivity:	-122 dBm for 12 dB SINAD unweighted.
Adjacent Channel Selectivity:	73 dB / 65 dB (WB/NB)
Intermodulation Rejection:	77 dB
Blocking:	100 dB
Spurious Rejection:	75 dB
Audio Rated Power:	3 Watts in 4 Ohms
RX Frequency Response:	- 6 dB / Octave, +1 dB / -3 dB, 300 Hz to 3 kHz.
Audio Signal to Noise	45 dB / 40 dB (WB/NB)
Conducted Spurious Emission:	- 80 dBm

#### Mechanical Specifications

Dimensions:	29 (H) x 127 (L) x 163 (D) mm
Weight:	620 grams

#### Environmental

Operating Temperature Range:	$-10^{\circ}\text{C}$ to $60^{\circ}\text{C}$
Storage Temperature:	$-30^{\circ}\text{C}$ to $70^{\circ}\text{C}$
Shock & Vibration:	MIL SPEC 810

\*Specifications are typical unless otherwise indicated and may be subject to change without notice or obligation.

# STANDARD COMMUNICATIONS CONTRACT WARRANTY

## 1. Statutory Warranties

- 1.1 The Trade Practices Act Part V, Division 2A and other legislation imply conditions, warranties and other obligations on us to consumers that cannot be excluded, restricted or modified. Those provisions apply to the extent required by law.
- 1.2 We exclude all other conditions, warranties and obligations which would otherwise be implied concerning the activities covered by this agreement.
- 1.3 We limit our liability where we are allowed to do so. Examples of where we are allowed to limit liability are -
  - (a) you acquire goods from us for re-supply;
  - (b) the goods or services we supply are not of a kind ordinarily acquired for personal, domestic or household use or consumption.
- 1.4 Where we are allowed to limit our liability, to the extent permitted by law, our sole liability for breach of a condition, warranty or other obligation implied by law is limited -
  - (a) in the case of goods we supply, to any one of the following as we decide -
    - (i) the replacement of the goods or the supply of equivalent goods;
    - (ii) the repair of the goods;
    - (iii) the payment of the cost of repairing the goods or of acquiring equivalent goods;
    - (iv) the payment of the cost of having the goods repaired; or
  - (b) in the case of services we supply, to any one of the following as we decide -
    - (i) the supplying of the services again;
    - (ii) the payment of the cost of having the services supplied again.

## 2. Additional Warranties

- 2.1 The warranties in this clause are in addition to the statutory warranties referred to in the previous clause.
- 2.2 We warrant our goods to be free from defects in materials and workmanship for two years from the date of original sale (or another period we agree to in writing). During this period and as our sole liability to you under this warranty, we agree to, at our option, either repair or replace goods which we are satisfied are defective. We warrant replacement parts for the

remainder of the period of warranty for the goods into which they are incorporated.

- 2.3 We warrant our other repairs to be free from defects in materials and workmanship for three months from the date of the original repair. During this period and as our sole liability to you for the repair, we agree to repair or replace (at our option) repaired goods which we are satisfied are defective.
- 2.4 We warrant that we will perform services with reasonable care and skill and agree to investigate any complaint made in good faith that we have performed services unsatisfactorily. If we are satisfied that the complaint is justified, and as our sole liability to you under this warranty, we agree to supply those services again at no extra charge to you.
- 2.5 If you want warranty service under this clause you must give us an original or copy of the sales invoice from the transaction or some other evidence showing details of the transaction.

## 3. Other Limitations

- 3.1 You may not rely on any representation, warranty or other provision by or for us which is not covered by clause [ 1 ] or repeated in this agreement in clear terms.
- 3.2 We are not liable (nor are our employees, contractors and agents) for any damage, economic loss or loss of profits whether direct, indirect, general, special or consequential -
  - (a) arising out of any breach of any implied or express term, condition or warranty; or
  - (b) suffered as a result of our negligence (or that of our employees, contractors or agents) apart from liability as set out in the previous two clauses.
- 3.3 The liability of a party under this agreement (whether arising in contract, tort or by statute) is to be reduced by the same proportion as represents the proportion of the loss or damage caused or contributed to by the other party, its contractors or agents.

## GME After Sales Service

Your GME TX3800 is especially designed for the environment encountered in mobile or portable applications. The use of all solid state circuitry, careful design and rigorous testing, result in high reliability. Should failure occur however, GME maintain a fully equipped service facility and spare parts stock to meet the customer's requirements long after expiry of the warranty period.



A Division of: **Standard Communications Pty. Ltd.**



ISO 9001:2008  
SO 9001: 2008  
AU97/0906  
List of certified characteristics available at [www.sgs.com](http://www.sgs.com)

Authorised Dealer:  
[www.cimconcepts.com.au](http://www.cimconcepts.com.au)

**CIM** concepts  
Communication & Information on the Move

[www.cimconcepts.com.au](http://www.cimconcepts.com.au)  
Ph 03 8802 0387